

37" Ultra-Wide Stretched Bar Displays



Perfect as a banner-style endcap display in retail stores and supermarkets

Versatile Retail Solution

Whether being used as part of an end-aisle display or as a unique individual screen, this solution offers a versatile range of possible applications. The flexibility of portrait or landscape use and the ultra-wide aspect ratio make them the perfect accompaniment for our LCD Shelf Edge Displays.



High Brightness



IPS Panel



Narrow Bezel



Clear HD Resolution



Android Media Player



Unique Aspect Ratio



Free Wall Mount



24/7 Commercial Grade



3-Year Warranty



Lifetime Technical Support

Other Features

Streamlined Enclosure

Designed to maximise the impact of content, these displays feature a sleek, narrow bezel. This is especially important when placing multiple screens together. The compact design also adds to the aesthetic and reduces strain on shelf edges.



1,000cd/m² High Brightness

Designed for brightly-lit retail spaces, these displays are sure to make your content really stand out with almost four times the brightness level of a standard domestic TV.



IPS Panel

Ideal for portrait use, commercial grade IPS panels guarantee incredible image quality and colour depth at an ultra-wide viewing angle in any direction without any fall-off in colour accuracy.



Free Network Upgrade

These displays come with a free upgrade to unlock network CMS functionality. The built-in Android media player also allows you to easily update the screen via USB plug and play or using third-party software if necessary.



Multiple Media Zones

Create engaging content that utilises in text and even live webpages by sectioning the display into different media zones.



Clear HD Resolution

Unlike DV-LED stretched displays, this solution uses a full HD LCD panel to provide a clear image and fine details. This high resolution is essential to be able to read text at close proximity and also produces the best results when showing video.

1920x540
RESOLUTION

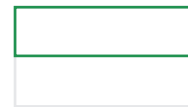

24/7 Commercial Grade

Designed for supermarkets and other retail spaces, these displays utilise a commercial grade LCD panel, LED backlight and internal components. This means they can run constantly 24/7 for over 70,000 hours.



Multiple Inputs

If you need to use the screen as a monitor, you can connect it to an external source, such as a third-party PC or media player, using the HDMI or VGA and 3.5mm audio jack inputs.

- 1 LAN
- 2 HDMI
- 3 VGA
- 4 Audio in
- 5 2 x USB

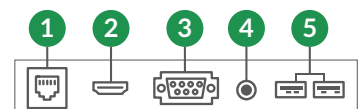

Key Features



ULTRA-WIDE ASPECT RATIO



HIGH BRIGHTNESS

IPS

IPS PANEL

HD

CLEAR HD IMAGE



24/7 COMMERCIAL GRADE



PLUG AND PLAY



NETWORK UPGRADE



OTHER SIZES AVAILABLE



DIGITAL ENDCAP BANNER

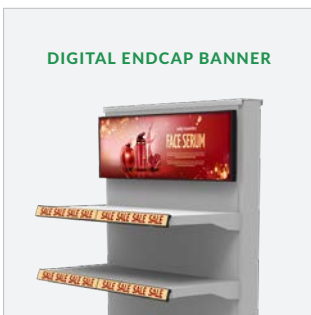

NARROW BEZEL

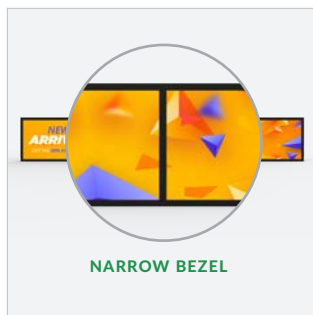

MULTIPLE MEDIA ZONES

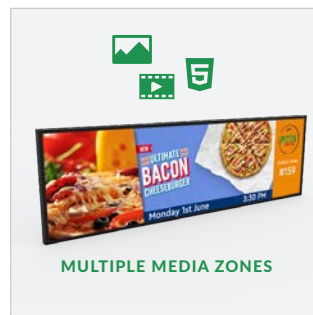

CONNECT DEVICES

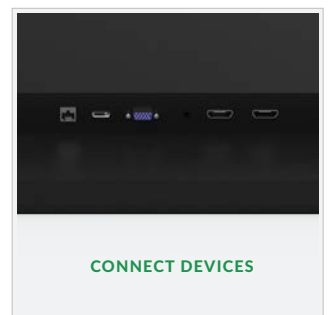

Specification Table

		37 Inch
Panel	Resolution	1920x540
	Display Area (mm)	919.3x259.55
	Aspect Ratio	32:9
	Brightness (cd/m ²)	1,000
	Colour	16.7M
	Viewing Angle	89°
	Contrast Ratio	1,000:1
AV Inputs	Video	HDMI, VGA
	Audio	Audio Socket (3.5mm)
Power	Power Consumption (W)	36
	Input Voltage	AC110~240V (50Hz~60Hz)
Mechanical	Unit Size (WxHxD mm)	954.5x291.5x51.5
	Package Size (WxHxD mm)	1055x390x220
	VESA Holes (mm)	100x100
	Net Weight (Kg)	8
	Gross Weight (Kg)	9
Environmental	Operating Temperature	0°C to 40°C
	Storage Temperature	-10°C to 60°C
	Operating Humidity	10% to 85%
	Storage Humidity	5% to 95%
Computer	Media Formats	Video (MPG, AVI, MP4, RM, RMVB, TS), Audio (MP3, WMA), Image (JPG, GIF, BMP, PNG)
	Media Resolution	1920x540
	CPU	Quad-Core ARM Cortex A17, 1.6GHz
	GPU	Quad-Core ARM Mali-T764
	RAM	DDR3 2GB
	Internal Storage	8GB eMMC
	USB	1 x USB (OTG/HOST), 1 x USB (HOST)
	LAN	100M/1000M Ethernet (Network Version Only)
	Wi-Fi	802.11b/g/n (Network Version Only)
	Bluetooth	Bluetooth 4.0
	OS	Android 7.1
	Graphic Engine	OpenGL ES 1.1/2.0/3.0/3.1, OpenCL 1.1, Renderscript, Direct3D 11.1
	Accessories	Included
Optional		Network Upgrade, Wall Mount, Floor Stand/Trolley, Ceiling Mount, Table Stand
Warranty	Warranty Period	3 Year Warranty
	Technical Support	Lifetime

Errors and omissions excepted



Technical Drawing

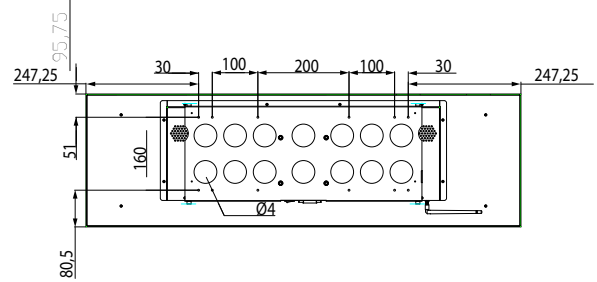
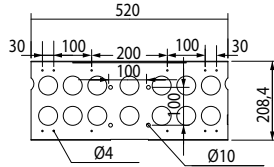
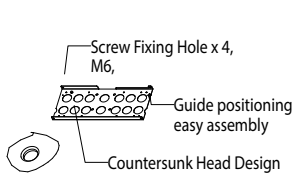
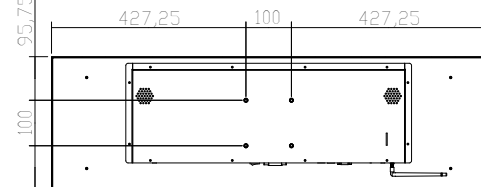
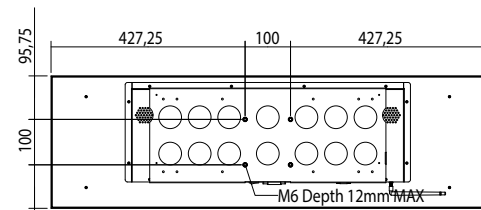
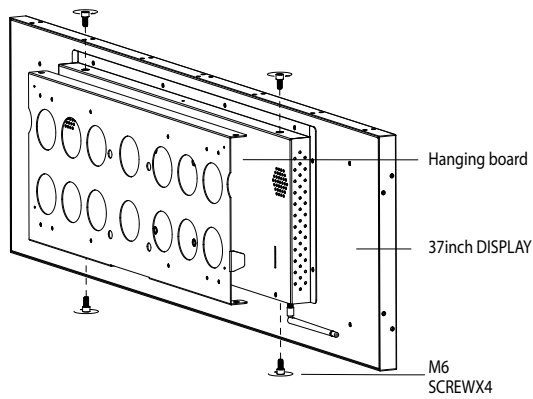
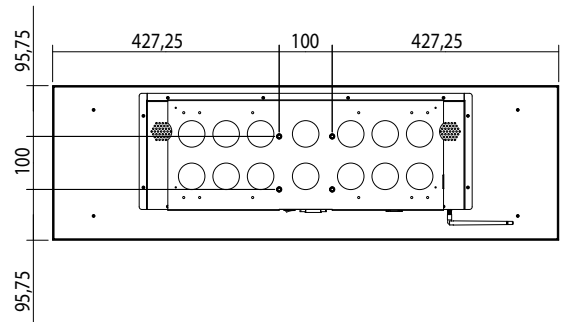
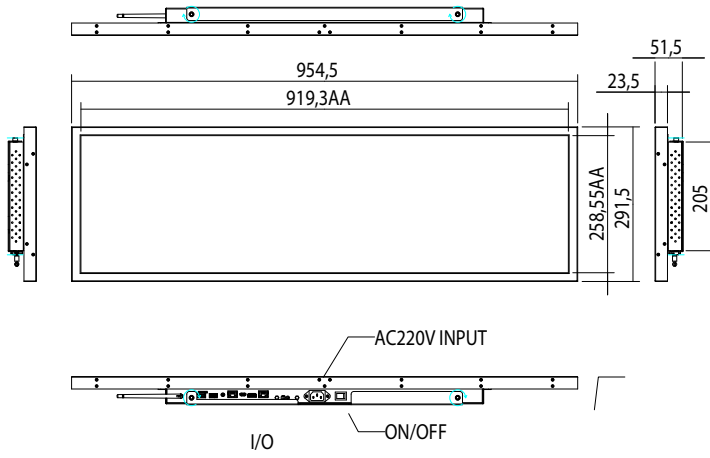

Why Choose Our Commercial Display Solutions?



Lifetime Technical Support

From the moment you receive your product, throughout the duration of your warranty and even after your warranty has expired we are here to support you. If you require any assistance setting up or using your product, or have any problems at all, we can provide free technical support via telephone and email.

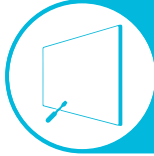

On-site Support and Maintenance*

If needed, we can provide an installation service for any of our products. We can also set up service-level agreements for larger projects that require maintenance contracts.



Extended Warranty*

All of our commercial display products come with a 3 year commercial warranty as standard but if you want to extend this you can upgrade this to cover a 5 year period at point of purchase.



Training

As well as providing free remote CMS training sessions and webinars we can also visit you to deliver bespoke training for our software and hardware*.



Advanced Replacements†

Should your display suffer from any kind of hardware failure during the warranty period we will send you an advanced replacement and arrange for your old display to be collected, free of charge. This ensures no downtime where you are without a screen.



Custom Product Testing & Configuration

If you need us to test third party software or a website, or configure your screen in a particular way before it is dispatched (e.g. in a particular orientation or network mode), we can do so to make your life easier.



3D Rendering

Want to know how a particular screen will look once installed? Send us a photo of the location and we will create a 3D rendering of any screen in situ to help you to visualise how amazing it will look.



Logistics Support

We hold more stock in our UK warehouse than any other manufacturer so we can help you meet tight deadlines. For last minute orders we can also offer special express or morning delivery options*. We also carry out UK based quality control checks on every display before it leaves our warehouse.



Project Support

If you need to loan a sample unit to test we'd be more than happy to arrange this. We can also provide a rental service for temporary projects*.



Customisation*

Your display can be customised to suit your requirements by adding your logo or printed graphics or even tailoring the colour of a display. We can also carry out hardware modifications to existing products or manufacture bespoke solutions for special projects.



Extras*

As well as being able to provide accessories and add-ons, such as extra remote controls, NUC PCs and video wall controllers, we can also supply custom made flight cases which are great if a display needs to be moved safely from place to place.

†UK mainland only

*These particular services may incur additional charges